

# FSSTOF1100D

High accuracy ranging distance: 1 – 10cm

## Data Sheet

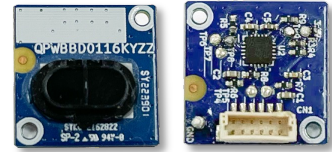

### Overview

FSSTOF1100D ToF module is a high-accuracy, easy-to-use ranging module with easy-to-set configuration parameters. For ranging applications, this product uses IIC and UART interfaces as its control interface. The UART communication mode supports the standard Modbus protocol. Support to modify the default address of the sensor, so that multiple groups of sensors can be connected to the system in the form of a bus.

### Applications

- Automatic faucet and flushing valve control
- Object detection for copying and vending machines, smart shelves
- Client detection for ATM and kiosk
- Obstacle avoidance for UAV and sweeper
- Factory automation
- Personnel passing and intrusion detection
- Appliance switch (ex. lamp control)
- Assisted focus for camera

### Features

- Safety Class 1 - 940nm Emitter, Compliant IEC 60825-1:2014-3rd edition working conditions
- High accuracy ranging distance: 1 – 10cm
- Fast response time for distance measurement
- Unique optical crosstalk compensation
- Single power supply
- Modbus protocol supply
- Communication address changeable
- Bus line interface,



**Rating and Property****Absolute Maximum Ratings: ( 25°C, unless otherwise specified )**

Parameter	Symbol	Scope	Unit	Remarks
Power supply voltage	VDD	-0.5 to 3.6	V	
I2C/UART voltage	VDDIO	-0.5 to 3.6	V	
Operating temperature	Topr	-20 to 70	°C	
Storage temperature	Tstg	-40 to 85	°C	

**Recommended Operating Conditions: ( 25°C, unless otherwise specified )**

Parameter	Symbol	Scope	Unit	Remarks
Power supply voltage	VDD	3.3V±5%	V	
I2C/UART voltage	VDDIO	2.7 to 3.5	V	
Recommended operating temperature	Topr	-20 to 70	°C	
IO low level	VIL	-0.25 to 0.5	V	
IO high level	VIH	2.7 to VDDIO+0.15	V	

**Electrical and Optical Characteristics**

Parameter	Symbol	Min.	Typ.	Max.	Unit	Remarks
Current consumption	ICC_dis	-	15	-	mA	33ms cycle
I2C clock frequency	Fi2c	1	-	100	KHz	
UART Baud rate	Fuart		9600		bps	

**VCSEL Characteristics**

Parameter	Symbol	Min.	Typ.	Max.	Unit	Remarks
VCSEL peak wavelength	$\lambda_{P\_PS}$	-	940	-	nm	
VCSEL FOV	Fov	-	25	-	°	

**Ranging Characteristics**

Parameter	Symbol	Min.	Typ.	Max.	Unit	Remarks
Range accuracy (20mm)	Rinw1	-6	-	+6	mm	White 88% Indoor: no infrared
Repeatability (20mm)	Rinrepw1	0	-	6	mm	
Range accuracy (100mm)	Ring3	-15	-	15	mm	Black 5% Indoor: no infrared
Repeatability (100mm)	Rinrep3	0	-	20	mm	
Min ranging distance	Rinlmin	-	-	3	mm	White 88% Indoor: no infrared
Max ranging distance	Ringmax	10			cm	Indoor: no infrared

**Ranging offset error**

Parameter	Symbol	Min.	Typ.	Max.	Unit	Remarks
Voltage drift	Vdrift			10	mm	T <sub>a</sub> =25°C, VDD=VDDV=VDDIO =3.2~3.4V
Temperature drift	Tdrift			15	mm	T <sub>a</sub> =-10°C~+60°C, VDD=VDDV=VDDIO=3.3 V

**Module outline dimension**

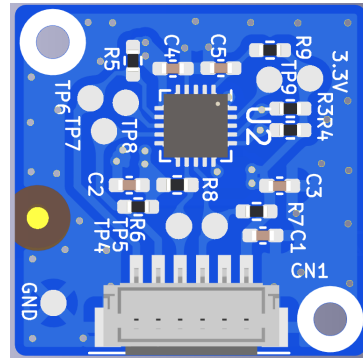
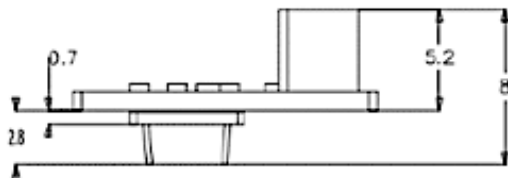
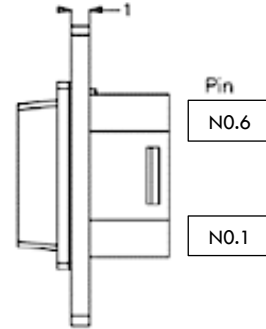
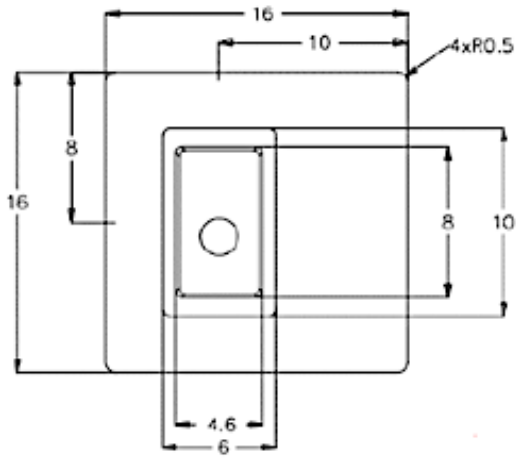

**Interface description**

Pin NO	Symbol	Function description
1	VCC	Power supply (3.3V)
2	GND	Power ground
3	SCL	IIC clock line
4	SDA	IIC data line
5	RXD	UART receive line
6	TXD	UART send line

Connector : JCTC 11002H00-6P-HF

## UART Communications

Parameter	Value
Baud	9600 bps
Data bit	8
Parity bit	None
Stop bit	1
Flow control	None

## Packet format

Following the Modbus standard protocol, a frame of data ADU consists of four parts: address bits + function code + data + correction code.

address bits	function code	data	checksum
--------------	---------------	------	----------

The function codes supported by this sensor are as follows:

Function code	Description
0x03/0x04	Read register
0x06	Write a single register
0x10	Write multiple registers

The default Modbus address is 0x00, which can be changed by customers and stored in a non-volatile memory.

The verification type is CRC16 MODBUS mode. The calculation formula is as follows:

$$X^{16} + X^{15} + X^2 + 1$$

Since the address byte and the checksum code are handled exactly the same, only the PDU part is explained in detail.

## Read register

Host request :

Item	Data length (Byte)	Data content
Function code	1	0x03/0x04
Register start address	2	0x00 ~ 0x19
Number of registers	2	N (0 ~ 32)

Slave answer :

Item	Data length (Byte)	Data content
function code	1	0x03/0x04
Data length	1	2 * N
Number of registers	N * 2	-

## Write Single Register Operation

Host request :

Item	Data length (Byte)	Data content
Function code	1	0x06
Register start address	2	0x00 ~ 0x19
Number of registers	2	-

Slave answer :

Item	Data length (Byte)	Data content
Function code	1	0x06
Data length	2	0x00 ~ 0x19
Number of registers	2	-

## Write multiple register operations

Host request :

Item	Data length (Byte)	Data content
Function code	1	0x10
Register start address	2	0x00 ~ 0x19
Number of registers	2	N (1 ~ 31)
Data length	1	N * 2
Register data	N*2	-

Device answer :

Item	Data length (Byte)	Data content
function code	1	0x10
Data length	2	0x00 ~ 0x19
Number of registers	2	N (1 ~ 31)

## IIC Communication

Interface parameters :

Item	Parameter
IIC speed	100 kbps
IIC level	VCC internal pull-up
Default address	0x10(7bit)

The basic communication format is as follows :

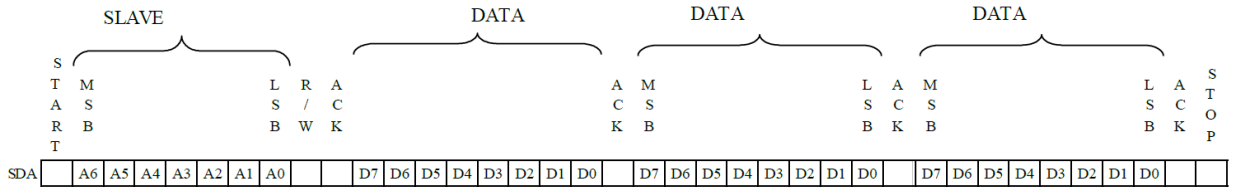

### IIC write data

The format of IIC writing data is as follows. Host can write single data or multi-data. Each register corresponds to 2 Byte data, totaling 16bit.

When the address matches, the device will shake hands with the host each time it receives data.

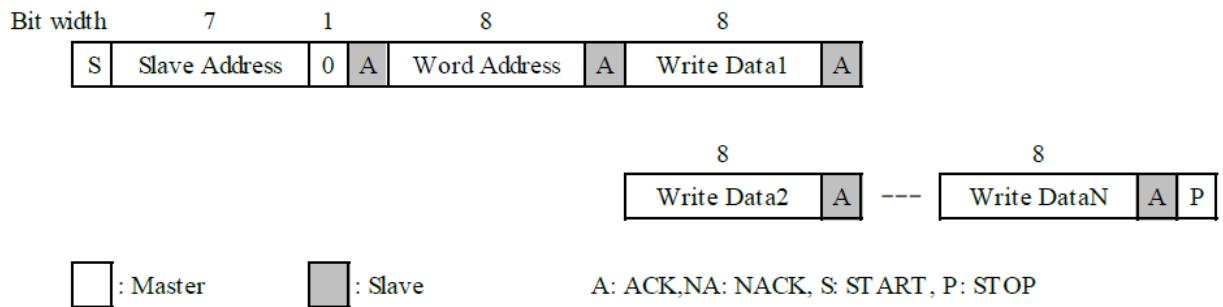

### IIC read data

When reading the register data, write the address of the register firstly, then read again. The host responds to the data with ACK when it continues to read the data, otherwise respond with NACK for stop reading.

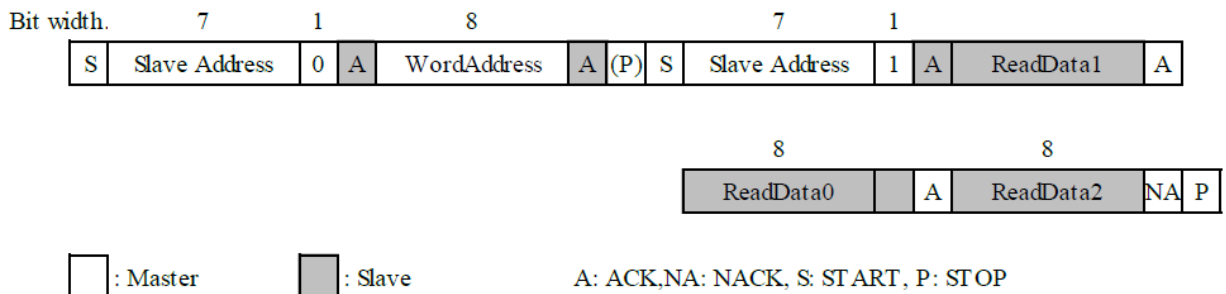

**Register description**

No (DEC)	No (HEX)	Definition
0	00	Distance result, mm unit
1	01	Device running status code: 0x0000 : valid data Others : invalid data
2	02	Ranging command 1: Start 0: Stop
3	03	-
4	04	-
5	05	-
6	06	-
7	07	-
8	08	-
9	09	-
10	0A	-
11	0B	-
12	0C	-
13	0D	-
14	0E	01: Write from RAM to NVM 02: Read Data from NVM 03: Read Data from NVM, factory default value
15	0F	-
16	10	-
17	11	-
18	12	-
19	13	Baud rate setting
20	14	Modbus address setting
21	15	I2C address
22	16	-
23	17	-
24	18	Module software main version
25	19	Module software minor version
26	1A	-
27	1B	-
28	1C	-
29	1D	-
30	1E	-
31	1F	-



## Quick Start

### Using UART Interface

STEP 1 > Ranging start

Host send

0x00	0x06	0x00	0x02	0x00	0x01	E8 (CRC Low)	1B (CRC High)
------	------	------	------	------	------	-----------------	------------------

STEP 2 > read data

Host send

0x00	0x04	0x00	0x00	0x00	0x02	0x70 CRC(Low)	0x1A CRC(High)
------	------	------	------	------	------	------------------	-------------------

Response

0x00	0x04	0x04	0x0001 (distance)	0x0002 (status)	CRC
------	------	------	----------------------	--------------------	-----

Set Modbus address

Host send

0x00	0x06	0x00	0x14	0x00	0x20	0xC9 CRC(Low)	0xC7 CRC(High)
------	------	------	------	------	------	------------------	-------------------

Response

0x00	0x06	0x00	0x14	0x00	0x20	0xC9 CRC(Low)	0xC7 CRC(High)
------	------	------	------	------	------	------------------	-------------------

※ It should be noted that the Modbus register address and data are arranged with the high byte first and the low byte last. The CRC check is the low byte first and the high byte last.

IIC communication adopts

STEP 1> Start measurement



STEP 2> Read Out Distance and Status

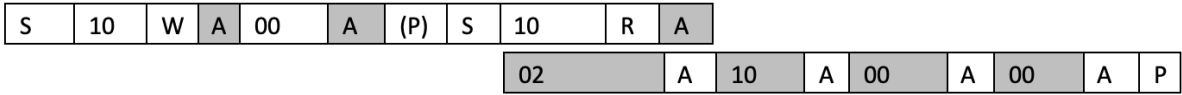

<p>S: start condition                  P: stop condition                  W: write, 0                  R: read, 1                  A: ACK response</p>
--

※ It should be noted that the Modbus register address and data are arranged with the high byte first and the low byte last. The CRC check is the low byte first and the high byte last.

## UART command list

Reading distance		The measured distance values are mm.
Send data	0x00 0x04 0x00 0x00 0x00 0x02 0x70(CRC Low) 0x1A(CRC High)	
Receive data	0x00 0x04 0x04 [0x00 0x01](distance) [0x00 0x02](states) 3B 45	
Start ranging		Ranging command 1: open 0: off
Send data	0x00 0x06 0x00 0x02 0x00 0x01 0xE8(CRC Low) 0x1B(CRC High)	
Baud rate setting		Set baud rate to 9600
Send data	0x00 0x06 0x00 0x13 0x00 0x96 0x00(baud) 0x70(CRC Low) 0x42(CRC High)	
Receive data	0x00 0x04 0x00 0x13 0x00 0x96 0x00(baud) 0x70(CRC Low) 0x42(CRC High)	
Modbus address setting		Set the Modbus address to 0x20
Send data	0x00 0x06 0x00 0x14 0x00 0x20 0xC9(CRC Low) 0xC7(CRC High)	
Receive data	0x00 0x06 0x00 0x14 0x00 0x20 0xC9(CRC Low) 0xC7(CRC High)	
I2C address setting		Set the I2C address to 0x30
Send data	0x00 0x06 0x00 0x15 0x00 0x30 0x99(CRC Low) 0xCB(CRC High)	
Receive data	0x00 0x06 0x00 0x15 0x00 0x30 0x99(CRC Low) 0xCB(CRC High)	
Read version		Read main version number
Send data	0x00 0x04 0x00 0x18 0x00 0x02 0xF0(CRC Low) 0x1D(CRC High)	
Receive data	0x00 0x04 0x04 [Main version number] [minor version number]CRC	

**Packing**

- **Tray**

Explain:

- 1 \ Material: PS blister, antistatic
- 2 \ Packing quantity: 5 rows and 10 columns, a total of 50 products on one floor
- 3 \ Size: 204 \* 204 \* 9.8 mm

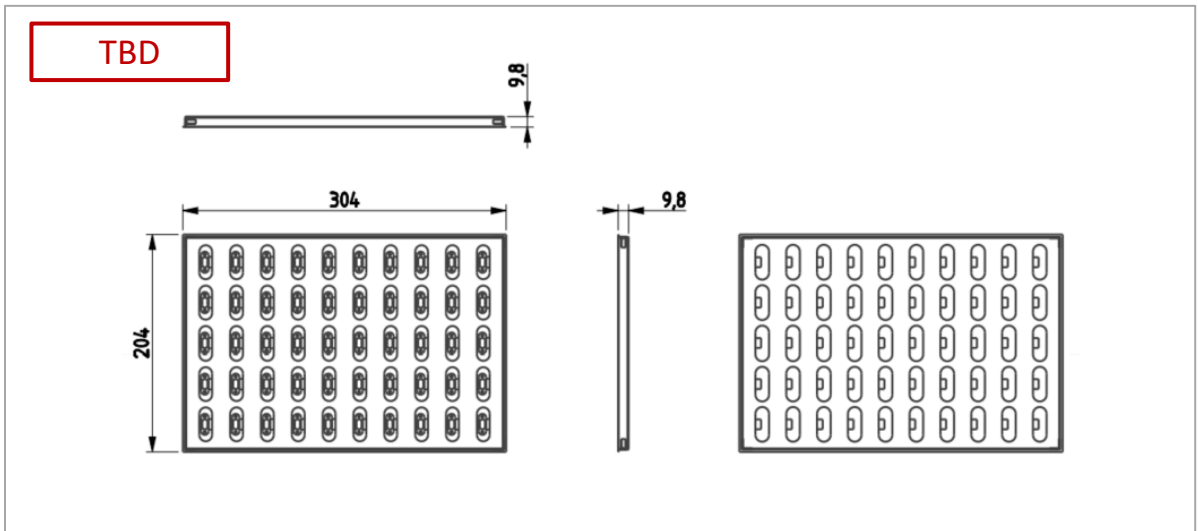

- **Outer Packing**

Explain:

- 1 \ Material: corrugated paper
- 2 \ Packaging quantity: 6 layers, one pallet per layer, 300 products in one packaging box
- 3 \ Size: 322.5 \* 222 \* 120 mm

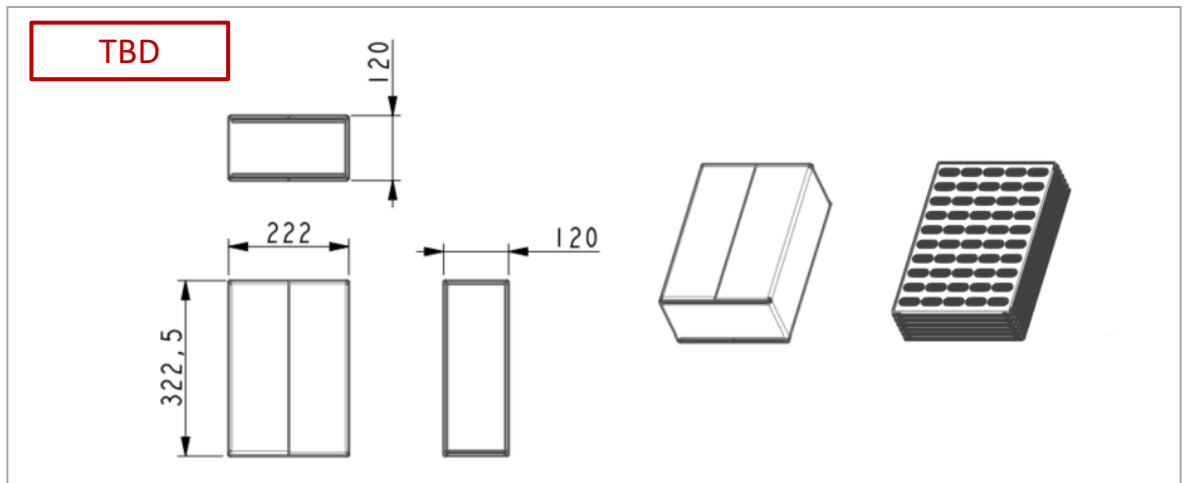

- Foxconn Technology Group\_Socle is continually improving the quality, reliability, function and design. Foxconn Technology Group\_Socle reserves the right to make changes without further notices.
- The warranty period for Socle product is one year after shipment.
- During the period, if there are any products problem, we will repair (if applicable), replace or refund. Except the above, both parties will discuss to cope with the problems.
- The failed Socle product after the above one year period will be coped with by Socle, provided that both parties shall discuss and determine on sharing responsibility based on the analysis results thereof subject to the above scope of warranty.
- The warranty described herein is only for Socle product itself which are purchased by or delivered to customer. Damages arising from Socle product malfunction or failure shall be excepted.
- To avoid damage to the equipment, it should be handled with care during all stages of storage, handling, assembly and testing, products should be protected from drops and bumps, and ESD protection and dust protection measures should be taken
- We will not be responsible for the Socle product due to the malfunction or failures thereof which are caused by:
  - (1) storage keep trouble during the inventory in the marketing channel.
  - (2) intentional act, negligence or wrong/poor handling.
  - (3) equipment which Socle products are connected to or mounted in.
  - (4) disassembling, reforming or changing Socle products.
  - (5) installation problem.
  - (6) act of God or other disaster (natural disaster, fire, flood, etc.)
  - (7) external factors (abnormal voltage, abnormal electromagnetic wave, fire, etc.)
  - (8) special environment (factory, coastal areas, hot spring area, etc.)
  - (9) phenomenon which cannot be foreseen based on the practical technologies at the time of shipment.
  - (10) the factors not included in the product specification sheet.
- The products shown in this publication are designed for the general use in electronic applications such as office automation, equipment, communications devices, audio/visual equipment, electrical application and instrumentation purpose, non-infringement and merchantability.
- This product is not intended to be used for military, aircraft, medical, life sustaining or lifesaving applications or any other application which can result in human injury or death.
- Please contact Socle sales agent for special application request.
- Parameters provided in datasheets may vary in different applications and performance may vary over time. All operating parameters, including typical parameters, must be validated in each customer application by the customer's technical experts. Product specifications do not expand or otherwise modify Socle's terms and conditions of purchase, including but not limited to the warranty expressed therein.

**FOXCONN**<sup>®</sup>  
HON HAI TECHNOLOGY GROUP



SOCLE Technology  
[www.socle-tech.com](http://www.socle-tech.com)